

CATERPILLAR 3516B
DP2 System

CONTENTS

System Overview	3
Offshore Rig or Ship DP2 Package	3
Main Generator Diesel Skid	3
Main Generator Diesel Engines	3
Instrument, Alarms and Automatic Start/Stop System	4
Main Generator Diesel Control Panel	4
Main Generators	5
Instrumentation & Control	5
Electrical System	6
Containerized Diesel Generator Sets	6
General Arrangement Drawing - Auxiliary Generator Pkg.	7
Power Distribution and Control (w/ Diagrams)	8
Fuel Oil System (Tanks, Supply, Pumps, Transfer Pumps and Piping)	9
Lubrication Oil System for Thrusters	9
Duplex DP, Thruster Control & Joystick Systems (w/ Diagram)	9
Fresh Water Cooling System (Box Coolers, VSD Coolers and Expansion Tanks)	10
Variable Speed Drives, UPS's and Frequency Converters	10
Switchboards	10
Block Diagram - Main Power Distribution	10
Emergency 440V Power Distribution Panel (w/ Diagram)	11
Thruster Auxiliary 440V Power Distribution Panel (w/ Diagram)	12
Azimuth Thruster MV3000 Drive Networks to DP System (w/ Diagram)	13
Column C3 - 230V AC Supply Distribution for Sensors (w/ Diagram)	14
PME Cabinet KVM System Overview Diagram	15
A Series Thruster Control Desk Diagram	16
ATC/AJS Workstation Diagram	17
Summary of Control Equipment	18
Summary of Control Equipment (continued)	19
Thruster Electro Motor Diagram	20
690V Hyundai Generators Diagram	21
440V Hyundai Generators Diagram	22

SYSTEM OVERVIEW

Offshore Rig or Ship DP2 Package

- Containerized CAT 3516B Generator sets.
- Alstom Duplex DP2 System with VS Drives.

**Generators and DP2 System are Lloyds Marine Certified Complete with all Controls and Switchgear.
All Units are NEW 2008, never put into service, warranty transferable.**

Product as follows:

- 8 / ea. Units 3516B rated @ 1,840-kW cont. 690 volt 60 HZ @ 1,800 rpm Hyundai Generators
- 3 / ea. Units 3516B rated @ 1,840-kW cont. 440 volt 60 HZ @ 1,800 rpm Hyundai Generators
- 1 / ea. Unit 3412C rated @ 500-kW emergency standby 440 volt 60 HZ @ 1,800 rpm CAT SR4B Generator
- 1 / ea. NEW CAT Synchro System for Gensets.
- 8 / ea. NEW Alstom MSV 3000 VSD Drives provided.
- Not provided or included - 8 / ea. Wartsila FP Retractable Thrusters 1.6MW
- 8 / ea. NEW Hyundai Thruster Motors 1.6MW provided.
- 1 / ea. Complete Alstom DP2 Duplex System provided, all controls, drawings and certs available.
- 1 / ea. Hatenboer Fresh Water Osmosis System
- 1 / ea. Atlas Copco Air Compressors Model LT3-10 KE (10 bar (g) pressure)

General description of CAT / Hyundai Package Containerized Generator sets:

Main Engines:

8 / ea. 1,840-KW Prime 690 Volt Caterpillar Diesel Hyundai Generator Skids, Containerized equipped with ventilation insulation and exhaust for supply of power to the Azimuth Retractable Thrusters.

Auxiliary Systems:

3 / ea. 1,840-kW Prime 440 Volt Caterpillar Diesel Hyundai Generator Skids, Containerized equipped with ventilation insulation and exhaust for the supply of 440 volt for auxiliary systems to be transformed to 230VAC 1 phase + neutral.

Emergency Systems:

1 / ea. 500-kW Prime 440 Volt Cat Diesel Cat Generator Skid, Containerized equipped with ventilation insulation and exhaust for the supply of 440 volt for emergency systems to be transformed to 230VAC 1 phase + neutral and 24VAC 1 phase.

Main Generator Diesel Skid:

- Eight [8] Containers of A-0 in walls and roof to be delivered for Eight [8] Diesel Engine and Generator Skids for supply of Electrical Power 2,300 kVA, 690 V, 60 Hz for the Steer-Able Thrusters.
- Free access distance between engine/generator and container walls to be preferable 600mm.
- Each Container shall have Two [2] A-0 Sliding Doors. One door installed on each side of the container. When the containers are placed alongside each other, the sliding doors to meet for entering from one container to the next one. The doors are not to protrude outside the container.
- Each Container has a Ventilation System with registers in and out.
- The Containers are arranged as separate Engine Rooms with Fuel System, external top-mounted Exhaust System, Lube Oil System, Cooling Water System based on Air-Cooled Radiator System with Internal Radiators, Starting System, Bilge System, Light, Fire Fighting System, Instrument, Alarms and Automatic Start/Stop System according to class requirement. Brackets for installation of Fire/Flame Detectors to be installed.
- Lifting Eyes for Chain Blocks are installed above all Diesel Engines in container for maintenance work such as lifting in/out pistons or cylinder liners.
- All of the Containers are supplied with One [1] set of Standard Tools for maintenance of the Diesel Engines. Tools are located at wall-mounted Tool Panel inside the containers.
- All the Containers are equipped with heating according to Class notation. This is to prevent frost damage of all installed equipment during lay up in winter season with an outside temperature of 20degC.

Main Generator Diesel Engines:

- A standard built-on factory supplied Fresh Water Cooling System based on Air-Cooled Radiator System with Fresh Water Pump, Radiator (in machinery space) with Electrical Driven Cooling Fans, Electrical Water Heater with Circulation Pump. (Flexible pipe connections to engine)

A standard built-on factory supplied Fuel System with Fuel Injection Pump, Fuel Feed Pump, Primary Fuel Filter Duplex Element-Filter with Water Separator, Secondary Fuel Filter, double walled high pressure Fuel Lines, flexible fuel connections, Woodward Pro Act II Actuator mounted on engine, Woodward 2301 D (or similar) Electronic Governor.

The Fuel Oil System includes:

Internal separate A60 insulated Fuel Tank in each container for 8-hours running at 100% load. Internal A60 insulated Fuel Tank for 18-hours running at 100% load installed in the Emergency Diesel Generator Container.

A standard built-on factory supplied Lube Oil System consisting of direct-driven Lube Oil Pump, Duplex Lube Oil Filter, Bypass Lube Oil Filter, Lube Oil Cooler, Electrical Lube Oil Priming Pump, also prepared to drain the Oil Sump, Starter Cabinets.

A standard built-on factory supplied dry Exhaust Gas System equipped with Air Inlet Filters, Turbocharger, Charging Air Cooler, insulated Exhaust-Manifold, flexible Expansion Joints, and Exhaust Silencer 35 dBA with Spark Arrestors. Combustion Air Intake is arranged outside.

Turning Motor or Turning Gear with handle.

Flexible high elastic coupling fitted to Engine Flywheel and Generator Shaft

The power stated is valid for conditions in accordance with ISO 3046/1

Lifting Eyes for transport and installation

A standard built-in on factory supplied Starting System consisting of Electrical Starting Motors, Charging Rectifier, Starting Batteries in battery boxes separate starting system for each engine.

The Diesel Engines have a starting battery capacity for a minimum of 3 starts of each engine. The Emergency Generator has a minimum starting battery capacity for a minimum of 6 automatic starting attempts and 3 manual starting attempts.

Instrument, Alarms and Automatic Start/Stop System

Main Generator Diesel Control Panel:

Alarm Sensor for:

- Low Lube Oil Pressure
- High Lube Oil Temperature
- High Diff. Pressure over Lube Oil Filter
- High Water Temperature
- Low Cooling Water Flow
- Fuel leaks in double walled Fuel Lines
- Low Cooling Water Level in Expansion Tank
- Charging Air Pressure
- High Exhaust Gas Temperature after Turbocharger

Auto-Stop Device for:

- Low Lube Oil Pressure
- High Water Temperature
- Over Speed

Automatic Start and Shut Down System with following functions:

- LCD display showing voltage, rpm, oil pressure and temperature, water temperature, Charge air pressure and exhaust temperature after turbo.
- Automatic start attempts according to class requirement.
- Automatic shutdown for low oil pressure, high water temperature and over speed
- Start Switch
- Stop Switch
- Hour Meter
- Converter for serial communication
- Common Alarm and Shutdown Alarm
- Stop System
- 24 V Stop Solenoid Valve. The Control System includes interface prepared for a Dynamic Position Keeping System and a Power Management System arranged according to Lloyds Rules & Regulations.

-Additional Information:-

Diesel Oil:

The Diesel Engine complies with conditions in accordance with ISO 3046/1

Lubricating Oil:

Lubricating oil shall comply with the Diesel Engine manufacturer's recommendation.

Viscosity Class SAE 40 (ISO VG 150).

Content of additives should meet the requirements of MIL-L-2104 C or API Service CD.

Turbocharger: The oil may be mineral oil or synthetic oil having a viscosity of 30-55 cSt/50deg.C.

Output particulars:

8 / ea. Engines are dedicated to the Thruster Power:

Engine output Min 1,920-kW

Output speed: 1,800 rpm

3 / ea. Engines are dedicated to the Auxiliary Power Systems:

Engine output Min 1,920-kW

Output speed: 1,800 rpm

Main Generators:

All the Generators are supplied with:

- Automatic Voltage Regulator
- Equipment for parallel operation
- Anti Condense Heater
- PT-100 temperature sensors in windings
- PT-100 temperature sensors in bearings
- MCT Brattberg cable entry in container
- Termination Box for power cables
- Foundations.

All Auxiliary Engines and Emergency Generator are as follows:

- Engines and Generators are lined up on a common steel frame (skid), designed for being lifted in/out of machinery space for transport ashore in case of engine/generator breakdown.
- Vibration Dampers for mounting between skid frame and container floor. This to avoid vibrations in supporting structures.

Hyundai made Generators to the Diesel Engines are summarized:

- Eight [8] Generators for thrusters power 690 Volt Application Type: Brushless Self-Excited
- Location: Indoors
- Electrical Rating: 1,840-kW
- Speed: 1,800 rpm
- Frequency: 60 Hz
- Power Factor: 0.8
- No of phase: 3 ph
- Supply Voltage: 690 V
- Excitation: Self excited
- AVR: included
- Mounting / Enclosure
- Protection: IP 23
- Bearings: Re-greasable
- Cooling: Air Cooled
- Accessories / Fittings
- Temp sensing: 6 off stator RTD (PT 100) in windings
- 1 off RTD (PT 100) per bearing
- 1 off RTD Cooling air in
- 1 off RTD Cooling air out
- Anti Condensation Heater: 2 x 100 W, 220 V, 1 ph
- Water leakage detection: included

Instrumentation & Control:

The Eleven [11] Auxiliary Engines are configured to be controlled and monitored from a central Integrated Control System (ICS).

Interfaces are realized by means of distributed I/O modules communicating over a redundant bus system. Local Control of all main functions for the engines with Auxiliary Systems is included.

The Control System is laid out also to monitor and interface all critical failures and alarm situations for the Engines, Generators and Auxiliary Systems.

Electrical System:

The Thruster Power Distribution Systems are laid out for 690 VAC, 440VAC and 230 VAC/60Hz systems and 24 VDC Systems and to be controlled from the ICS Operating Stations.

Containerized Diesel Generator Sets

Item List Diesel Generator Sets:

- [8] off 690 Volt CAT Diesel - Hyundai Generator Skids. Containerized equipped with ventilation insulation and exhaust for supply of power to the Azimuth Retractable Thrusters.

- [3] off 440 Volt CAT Diesel - Hyundai Generator Skids. Containerized equipped with ventilation insulation and exhaust for the supply of 440 Volts for Auxiliary Systems to be transformed to 230 VAC 1-Phase + neutral.

- [1] off 440 Volt CAT Diesel - CAT Generator Skid. Containerized equipped with ventilation insulation and exhaust for the supply of 440 Volts for Emergency Systems to be transformed to 230 VAC 1-Phase + neutral and 24 VAC 1-Phase.

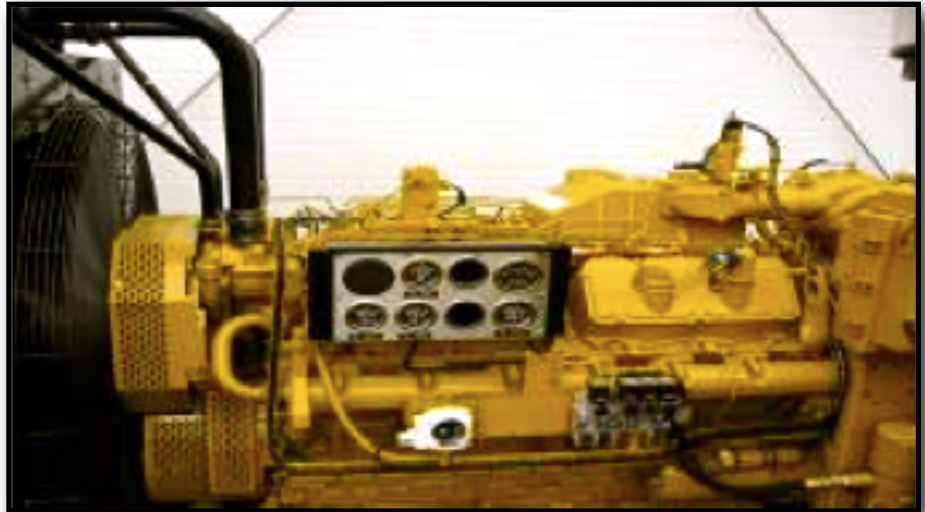

GENERAL ARRANGEMENT DRAWING - AUXILIARY GENERATOR PACKAGE

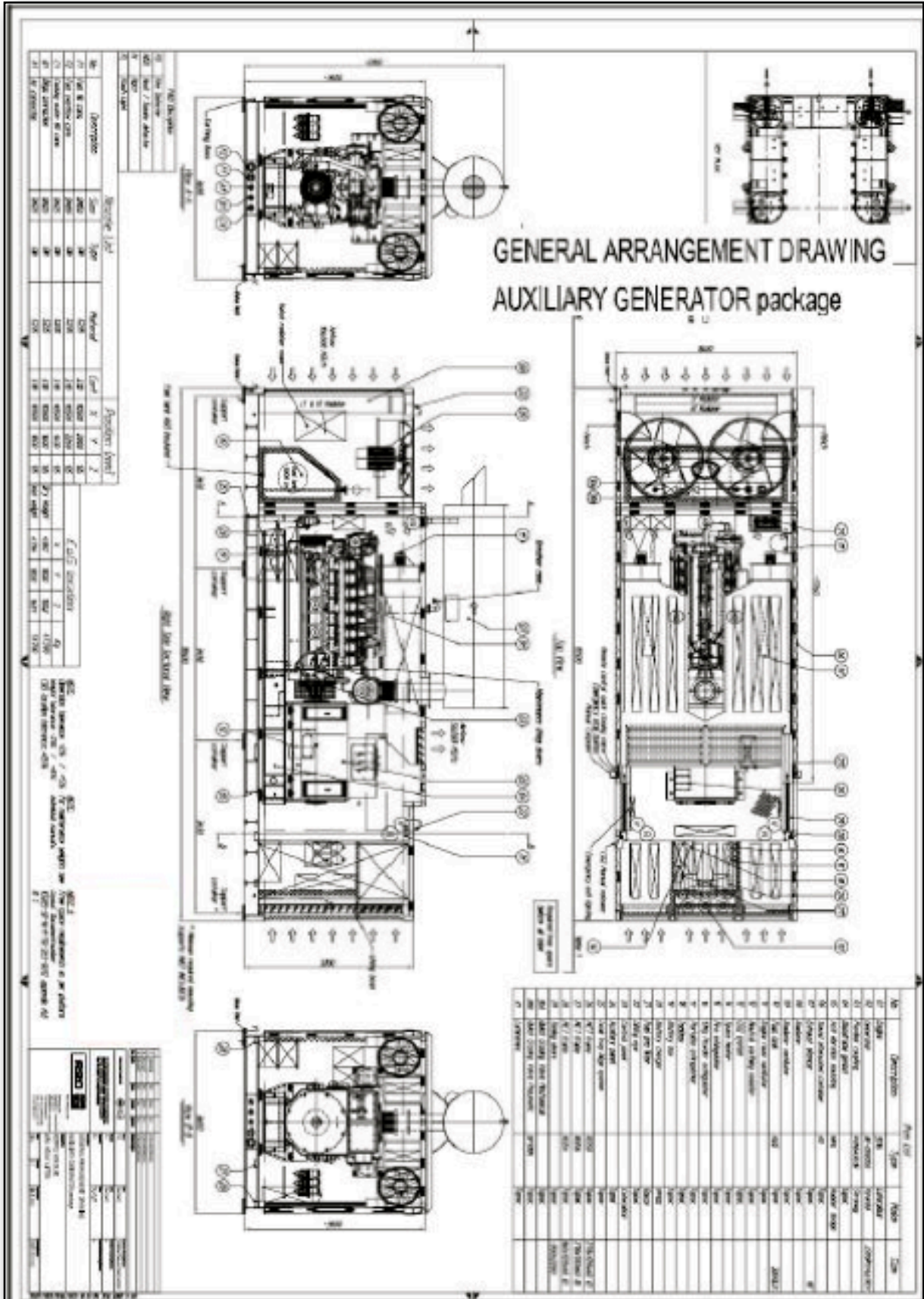

Power Distribution and Control:

■ Items List

Eight [8] off - Main Power Distribution Boards

Eight [8] off - Variable Speed Drive Cabinets

BLOCK DIAGRAM - MAIN POWER DISTRIBUTION

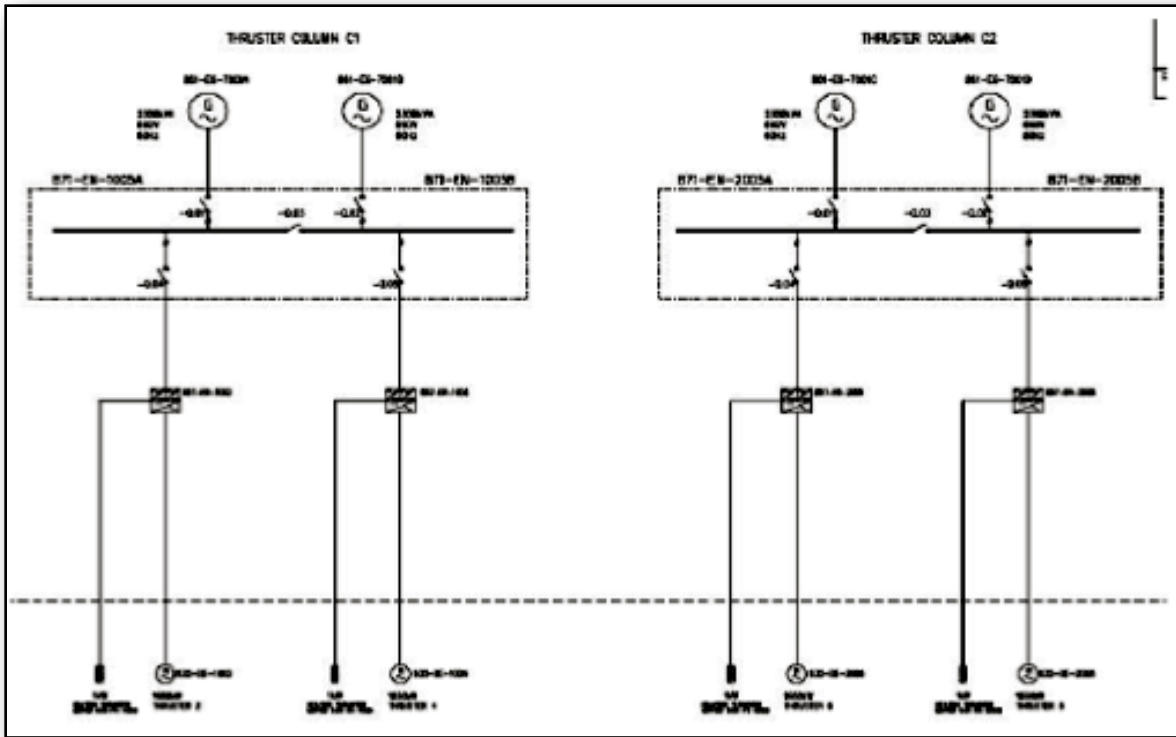

SYSTEMS FOR MACHINERY COMPONENTS

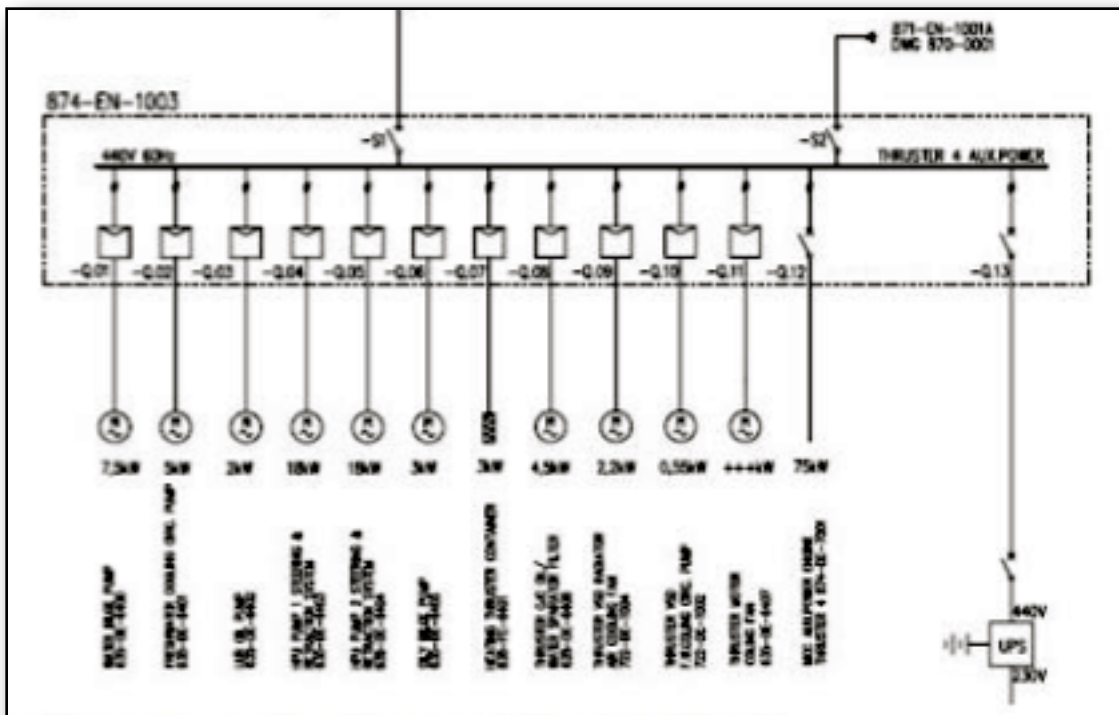

Fuel Oil System (Tanks, Supply, Pumps, Transfer Pumps and Piping):

Eight [8] Control Panels for Retractable Azimuth Thruster (speed control), each with:

- Combined lever for Thruster speed and Azimuth control
- Buttons and Status Lamps:
 - Start/Stop/Running
 - Thruster Hoist/Lower
 - Alarm/Fault
 - Command Transfer (Local/WH)
 - Emergency Stop
- Buzzer
- Bus communication to Thruster Controller
- Indicating Instruments:
 - Azimuth Indication
 - Rpm Indication
 - Power Indication

Lubrication Oil System for Thrusters:

Eight [8] TC-96 Thruster Controller (each max. 96 I/O), each with the following:

- Wall Mount Cabinet
- Single Real Time Processor, RCU510
- 64 multi-functional input/output embedded
- Dual Set Interface
- Lever Communication Link incl. HUB
- Serial Interfaces RS232/422/485
- Input Power - 24VDC from UPS (included)

NOTE:

Each Thruster Controller is integrated with the Local Control Panel of its corresponding Thruster.

DUPLEX DP, THRUSTER CONTROL AND JOYSTICK SYSTEMS

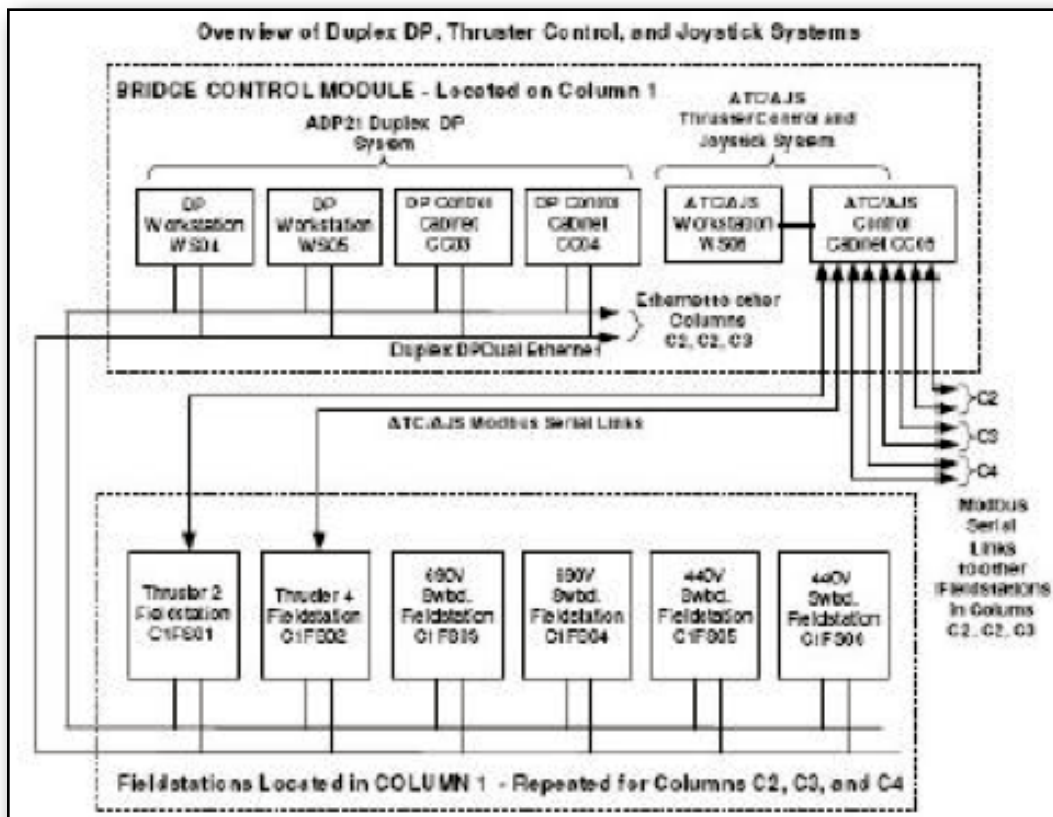

Fresh Water Cooling System (Box Coolers, VSD Coolers and Expansion Tanks):

Each of the Eight [8] VSD Cabinets arranged with a separate Fresh Water Cooling System, which requires minimum maintenance during operation. The closed circuit of the Fresh Water Cooling System shall by means of a Pump circulate fresh water through the built-in VSD Cabinet Cooler and the Cooling Radiator.

Variable Speed Drives, UPS's and Frequency Converters:

Eight [8] Variable Speed Drive Units, each with the following features:

- Floor-Mounted Cabinet
- Water Cooled

Switchboards:

Thruster Main 690V Power Distribution Panel:

Four [4] Main Distribution Panels

- Floor-Mounted

BLOCK DIAGRAM - MAIN POWER DISTRIBUTION

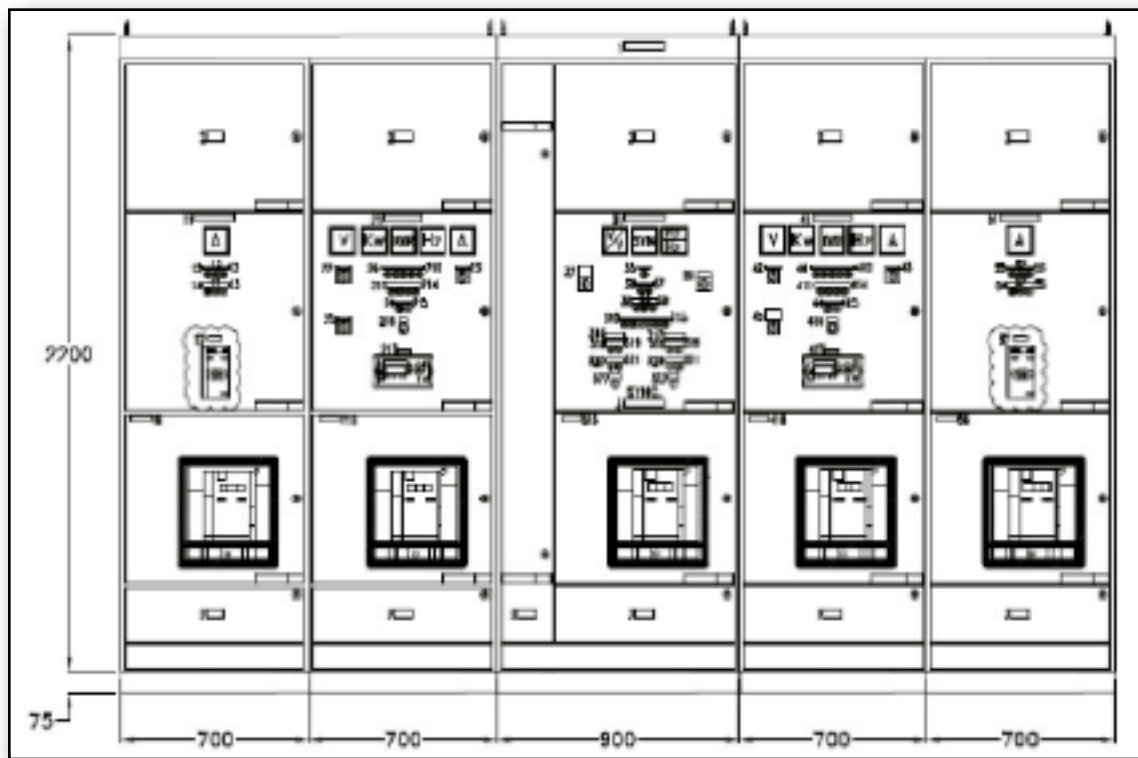

Emergency 440V Power Distribution Panel:

One [1] Emergency Power Distribution Panel

- Floor-Mounted Cabinet

EMERGENCY POWER DISTRIBUTION PANEL - 440V

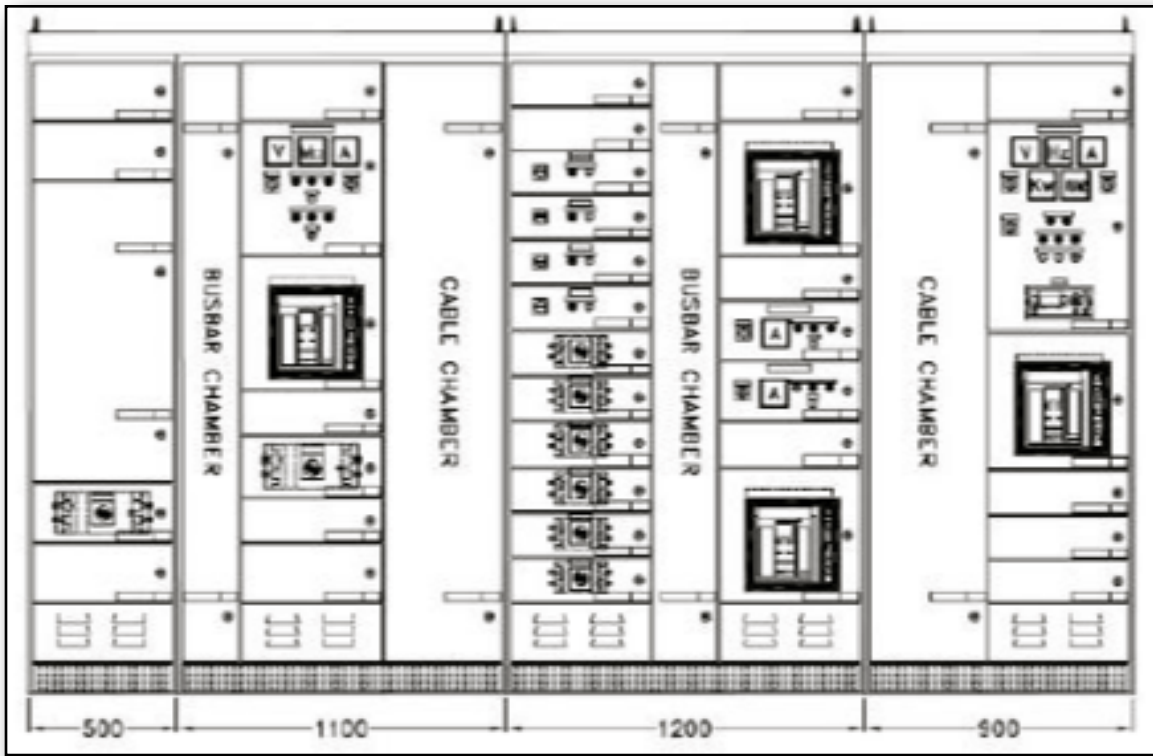

Thruster Auxiliary 440V Power Distribution Panel:

Four [4] Auxiliary Distribution Panels

The Distribution Boards provide power to the equipment listed and shown in the Auxiliary Power Distribution Block Diagram.

THRUSTER AUXILIARY POWER DISTRIBUTION PANEL - 440V

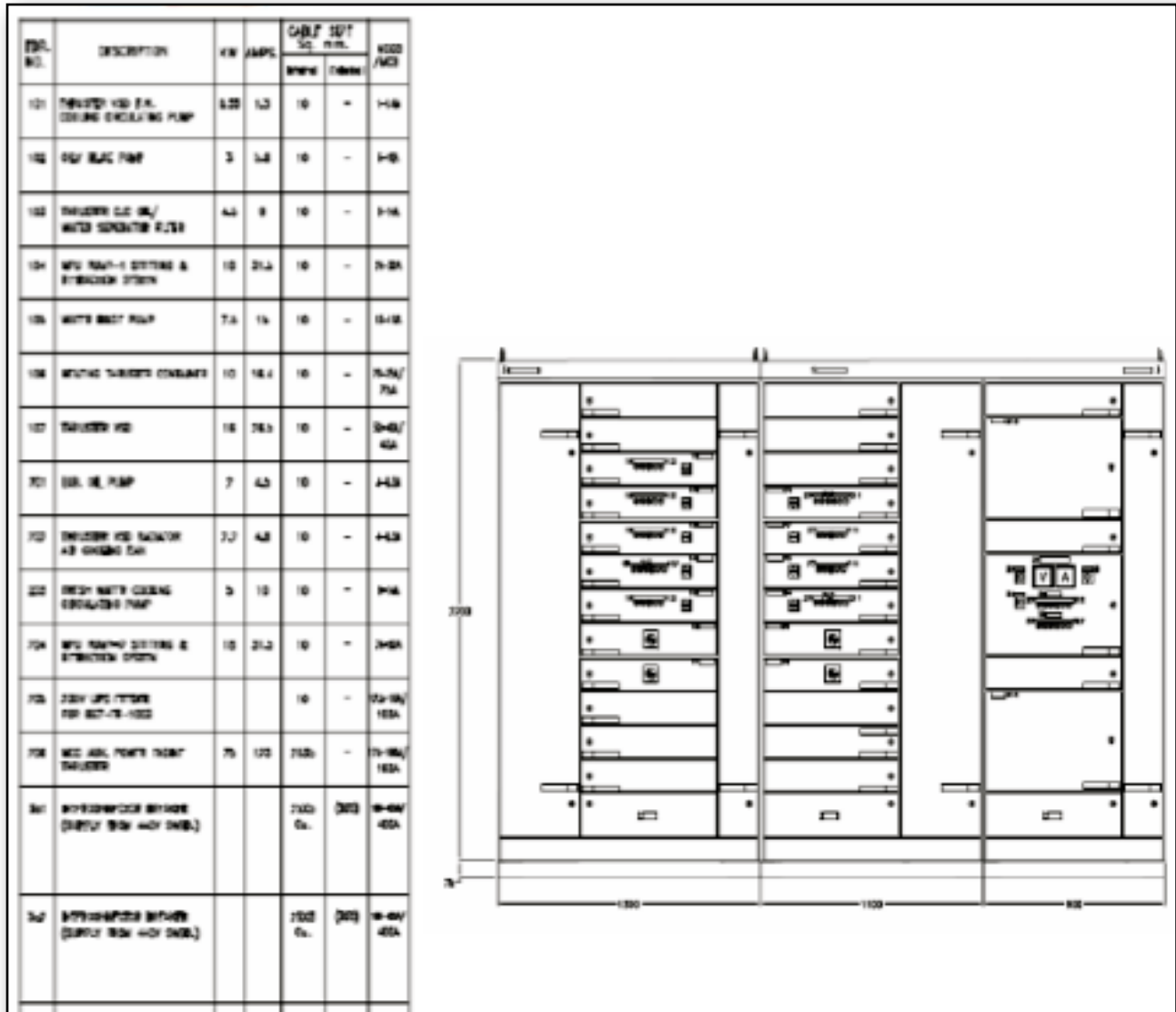

AZIMUTH THRUSTER MV3000 DRIVE NETWORKS TO DP SYSTEM

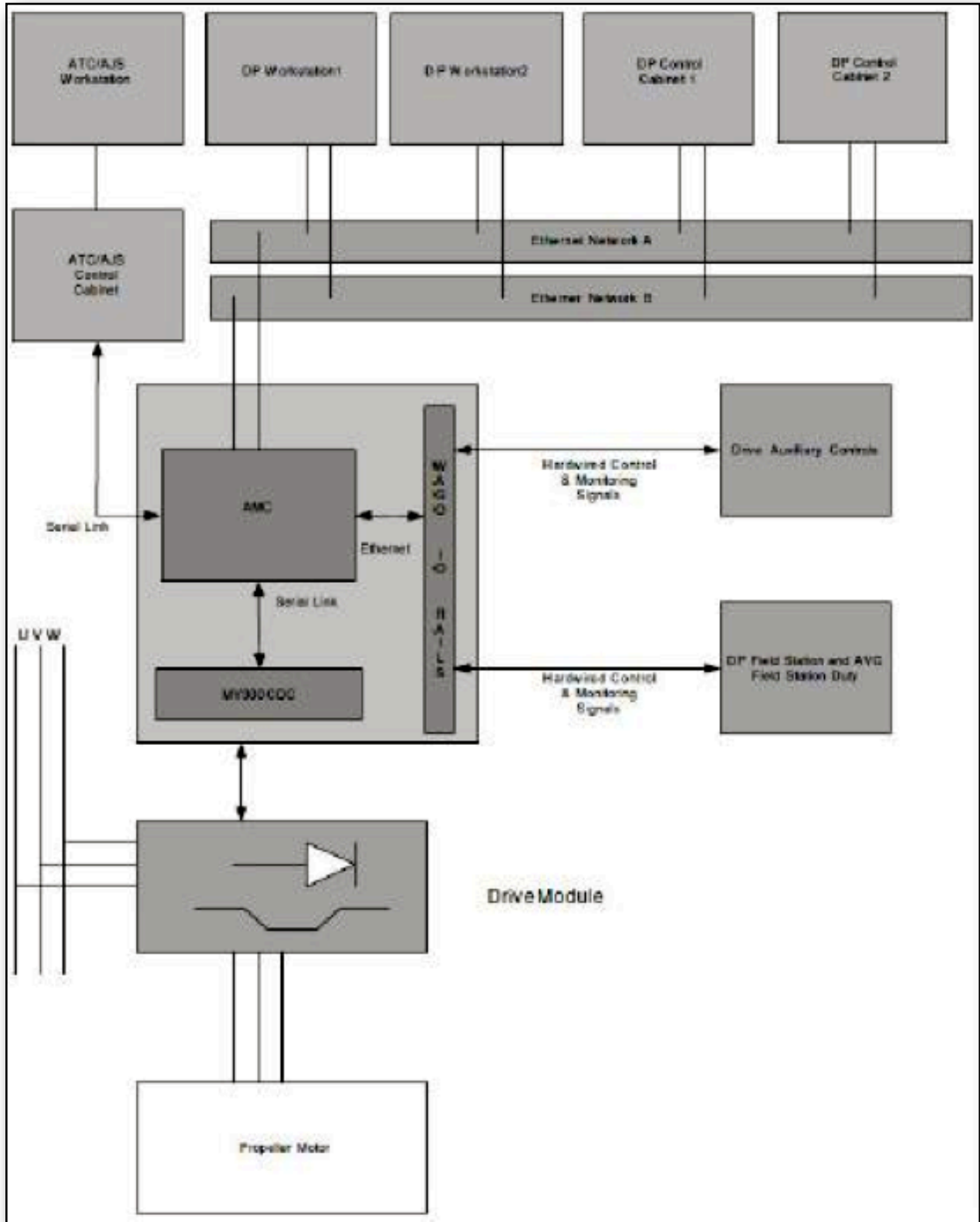

COLUMN C3 - 230V AC SUPPLY DISTRIBUTION FOR SENSORS

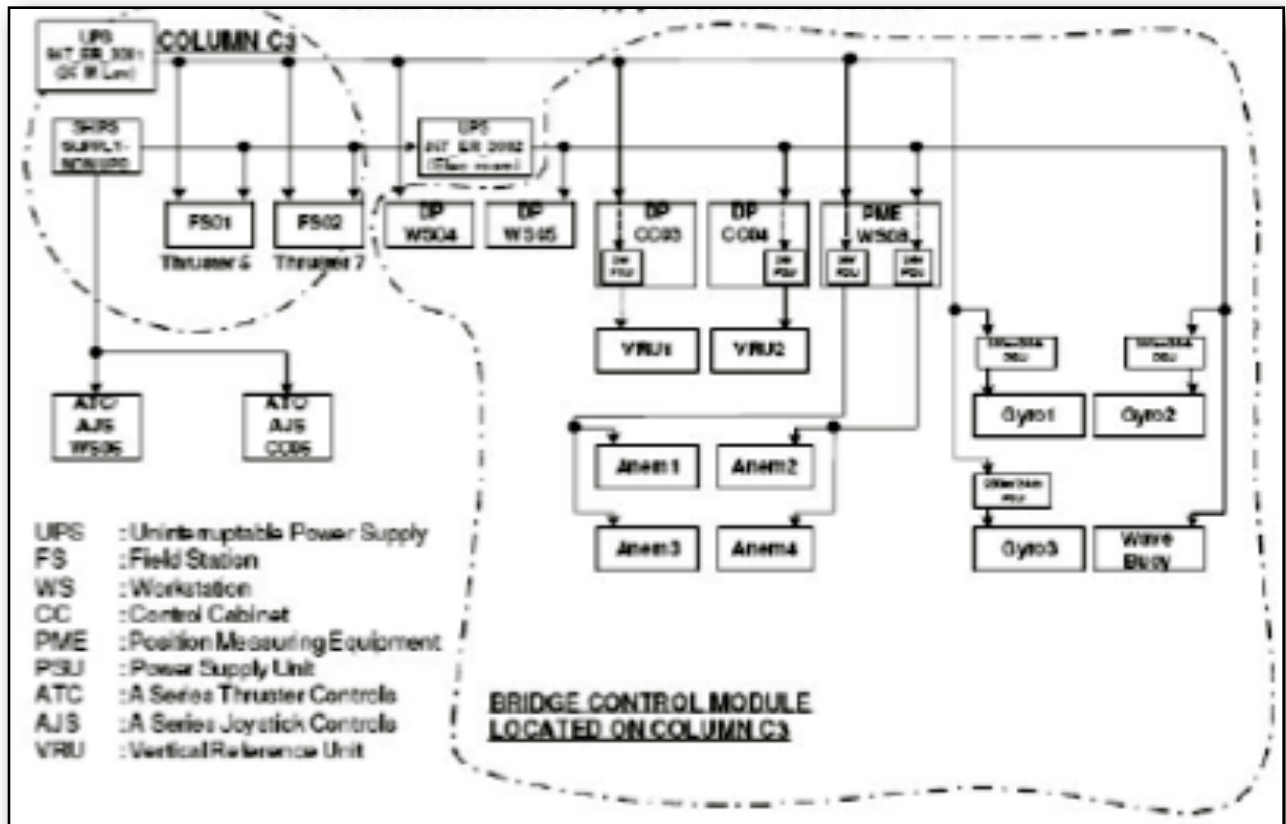

PME CABINET KVM SYSTEM OVERVIEW

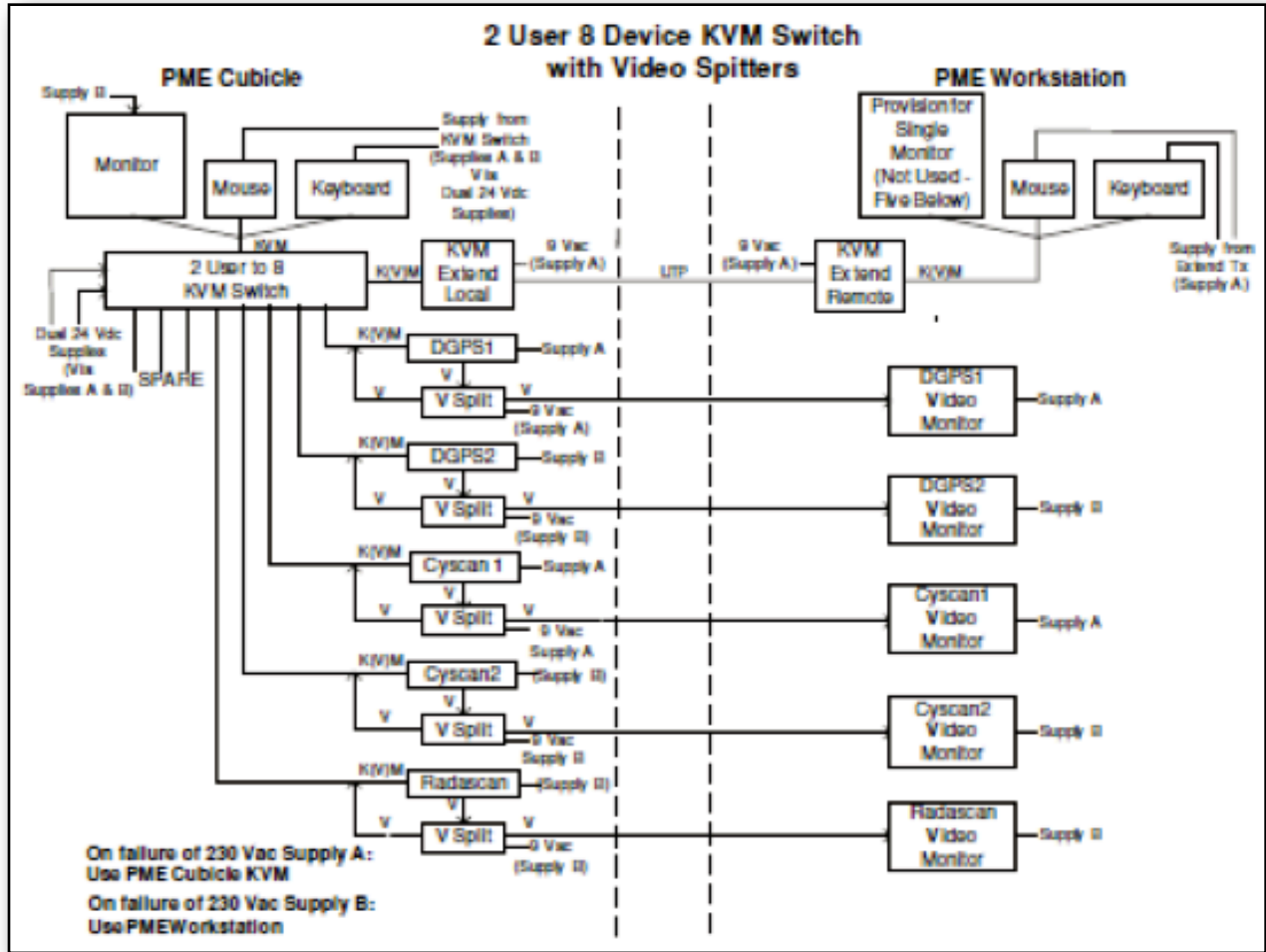

The **A Series Thruster Control (ATC) Desk** is double width. The **A Series Joystick Control (AJS)** is mounted on the front of the right hand side of the desk.

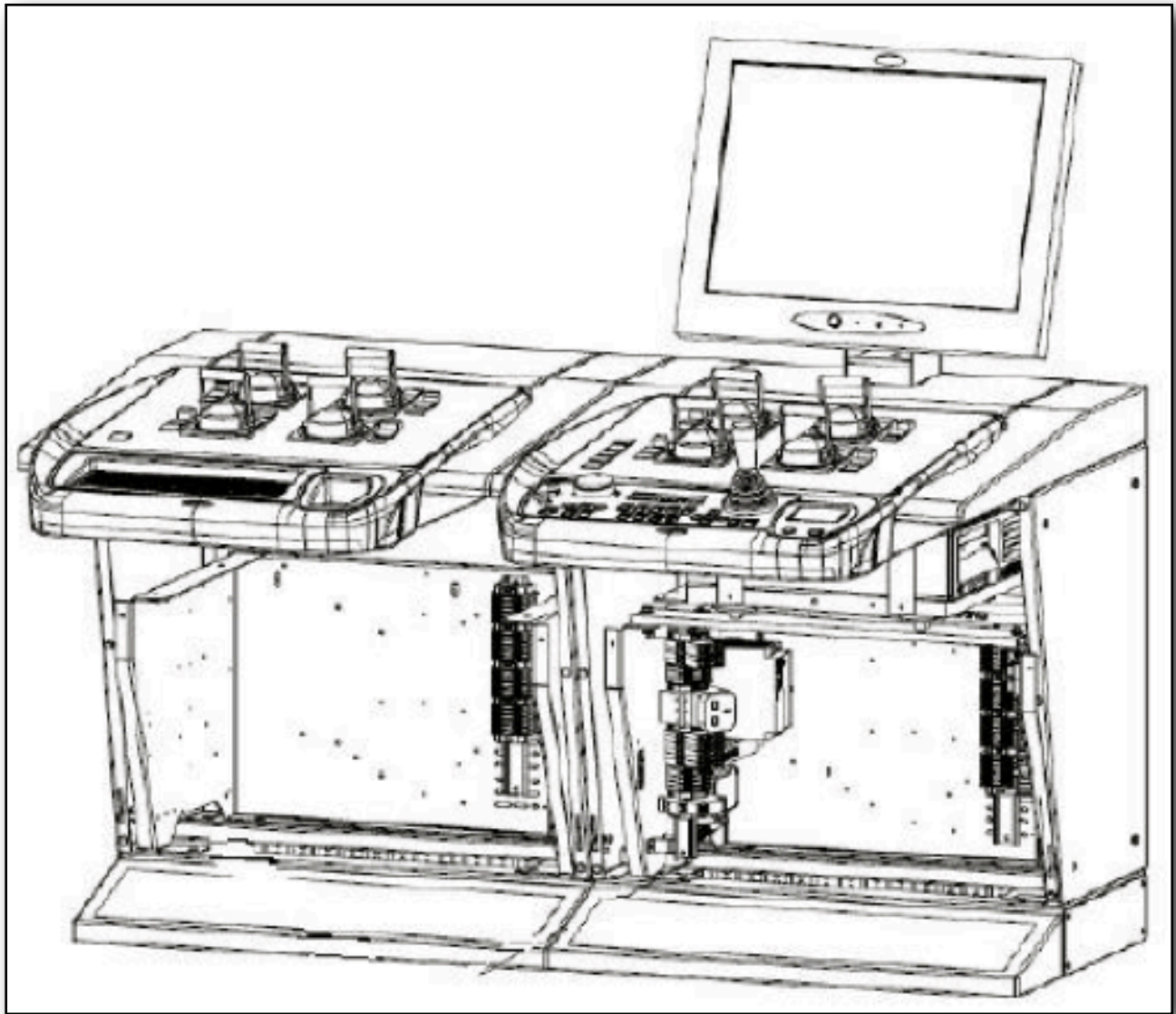

ATC/AJS WORKSTATION (WS06) - SHOWING LEFT HAND SIDE ATC DESK

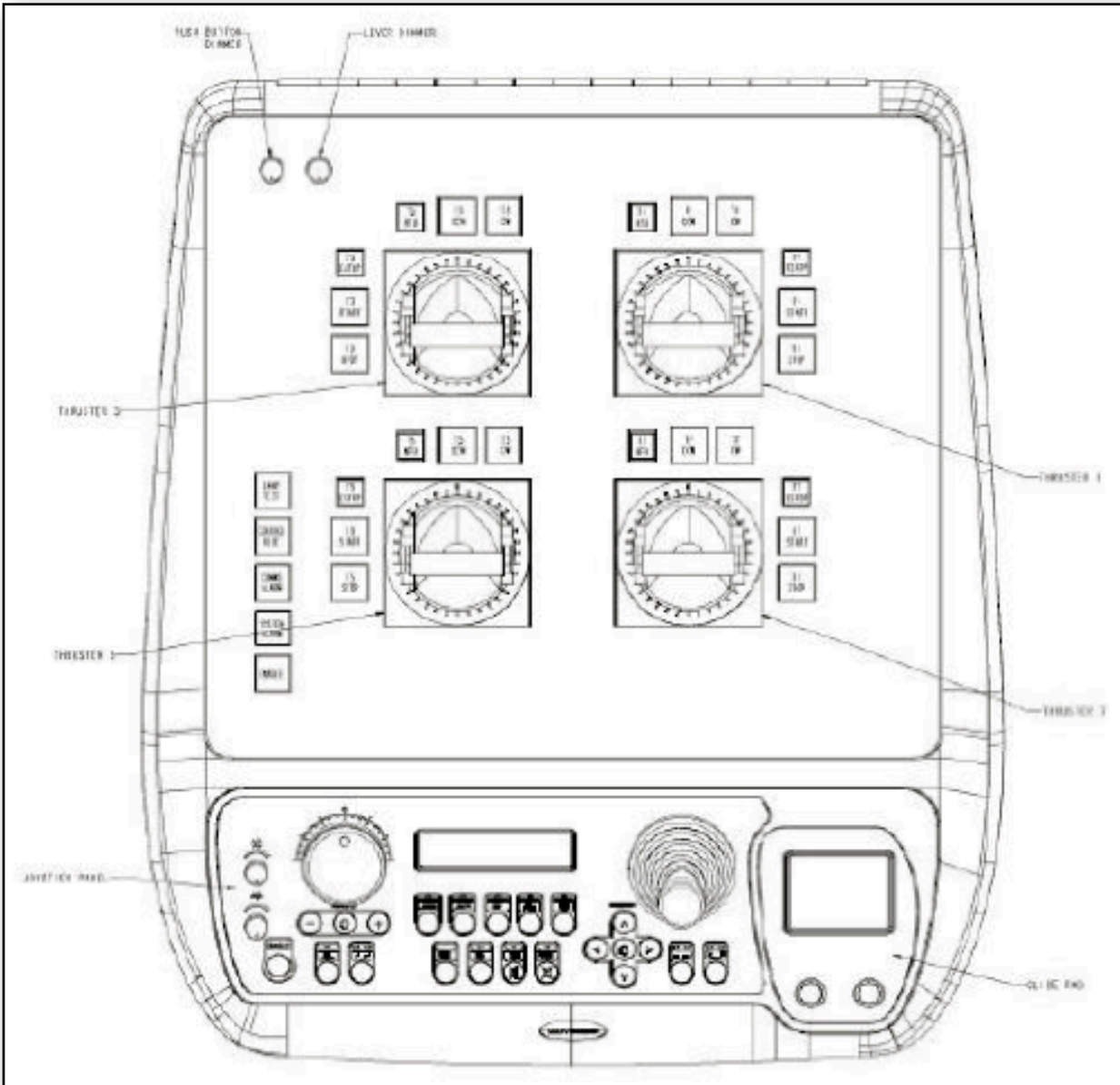

SUMMARY OF CONTROL EQUIPMENT

Switchboard Panel or equipment nr.	Type Switchboard / panel / field station or equipment	Footprint unpacked dimensions WxD
871-EN-1001A	Main switchboard 440V	2000x600
871-EN-1001A	Drive panel for 440V	2400x800
871-EN-1001B	Main switchboard 440V	2900x600
871-EN-1001B	Drive panel for 440V	2100x800
874-EN-1002	Thruster & engine MCC 440V	3300x600
874-EN-1003	Thruster & engine MCC 440V	3300x600
871-EN-1005A/B	Main switchboard 690V	3700x600
871-EN-4100A	Main switchboard 440V	2000x600
871-EN4001A	Drive panel for 440V	2400x800
871-EN-4001B	Main switchboard 440V	2900x600
871-EN-4001B	Drive panel for 440V	2100x800
874-EN4002	Thruster & engine MCC 440V	3300x600
874-EN-4003	Thruster & engine MCC 440V	3300x600
871-EN-4005A/B	Main switchboard 690V	3700x600
790-IR-1001G	Ballast I/O field station	1250x430
790-IR-1001A	Remote I/O field station VSD 690V	1200x300
790-IR-1001B	Remote I/O field station VSD 690V	1200x300
790-IR-1001C	Remote I/O field station main SWBD 690V	1200x300
790-IR-1001D	Remote I/O field station main SWBD 690V	1200x300
790-IR-1001E	Remote I/O field station main drive thruster 440V	1200x300
790-IR-1001F	Remote I/O field station main drive thruster 440V	1200x300
801-IB-1001	Balast local control cabinet	1000x250
790-IR-4001G	Balast remote I/O field station	1250x430
790-IR-4001A	Remote I/O field station VSD 690V	1200x300
790-IR-4001B	Remote I/O field station VSD 690V	1200x300
790-IR-4001C	Remote I/O field station main SWBD 690V	1200x300
790-IR-4001D	Remote I/O field station main SWBD 690V	1200x300
790-IR-4001E	Remote I/O field station main drive thruster 440V	1200x300
790-IR-4001F	Remote I/O field station main drive thruster 440V	1200x300
801-IB-4001	Balast local control cabinet	1000x250
867-ER-1002	VSD drive 690V	3500x900
867-ER-1004	VSD drive 690V	3500x900
867-ER-4001	VSD drive 690V	3500x900
867-ER-4003	VSD drive 690V	3500x900
867-ER-3005	VSD drive 690V	3500x900
867-ER-3007	VSD drive 690V	3500x900
867-ER-2006	VSD drive 690V	3500x900
867-ER-2008	VSD drive 690V	3500x900

Switchboard Panel or equipment nr.	Type Switchboard / panel / field station or equipment	Footprint unpacked dimensions WxD
7 PC	UPS Cabinet	955x620
8 PC	Lipstronic cabinet thruster	600x400
8 PC	Electric Motors	9 tons
871-EN-2001A	Main switchboard 440V	2000x600
871-EN-2001A	Drive panel for 440V	2400x800
871-EN-2001B	Main switchboard 440V	2900x600
871-EN-2001B	Drive panel for 440V	2100x800
874-EN-2002	Thruster & engine MCC 440V	3300x600
874-EN-2003	Thruster & engine MCC 440V	3300x600
871-EN-2005A/B	Main switchboard 690V	3700x600
10 PC	Lipstronic cabinet thruster	600x400
11 PC	Lipstronic cabinet thruster	600x400
790-IR-2001G	Ballast I/O field station	1250x430
13 PC	UPS Cabinet	955x620
790-IR-2001A	Remote I/O field station VSD 690V	1200x300
790-IR-2001B	Remote I/O field station VSD 690V	1200x300
790-IR-2001C	Remote I/O field station main SWBD 690V	1200x300
790-IR-2001D	Remote I/O field station main SWBD 690V	1200x300
790-IR-2001E	Remote I/O field station main drive thruster 440V	1200x300
790-IR-2001F	Remote I/O field station main drive thruster 440V	1200x300
801-IB-2001	Ballast local control cabinet	1000x250
871-EN-3001A	Main switchboard 440V	2000x600
871-EN-3001A	Drive panel for 440V	2400x800
871-EN-3001B	Main switchboard 440V	2900x600
871-EN-3001B	Drive panel for 440V	2100x800
874-EN-3002	Thruster & engine MCC 440V	3300x600
874-EN-3003	Thruster & engine MCC 440V	3300x600
871-EN-3005A/B	Main switchboard 690V	3700x600
10 PC	Lipstronic cabinet thruster	600x400
11 PC	Lipstronic cabinet thruster	600x400
790-IR-3001G	Ballast I/O field station	1250x430
13 PC	UPS Cabinet	955x620
790-IR-3001A	Remote I/O field station VSD 690V	1200x300
790-IR-3001B	Remote I/O field station VSD 690V	1200x300
790-IR-3001C	Remote I/O field station main SWBD 690V	1200x300
790-IR-3001D	Remote I/O field station main SWBD 690V	1200x300
790-IR-3001E	Remote I/O field station main drive thruster 440V	1200x300
790-IR-3001F	Remote I/O field station main drive thruster 440V	1200x300
801-IB-3001	Ballast local control cabinet	1000x250

EIGHT [8] OFF - 690V HYUNDAI GENERATORS DIAGRAM

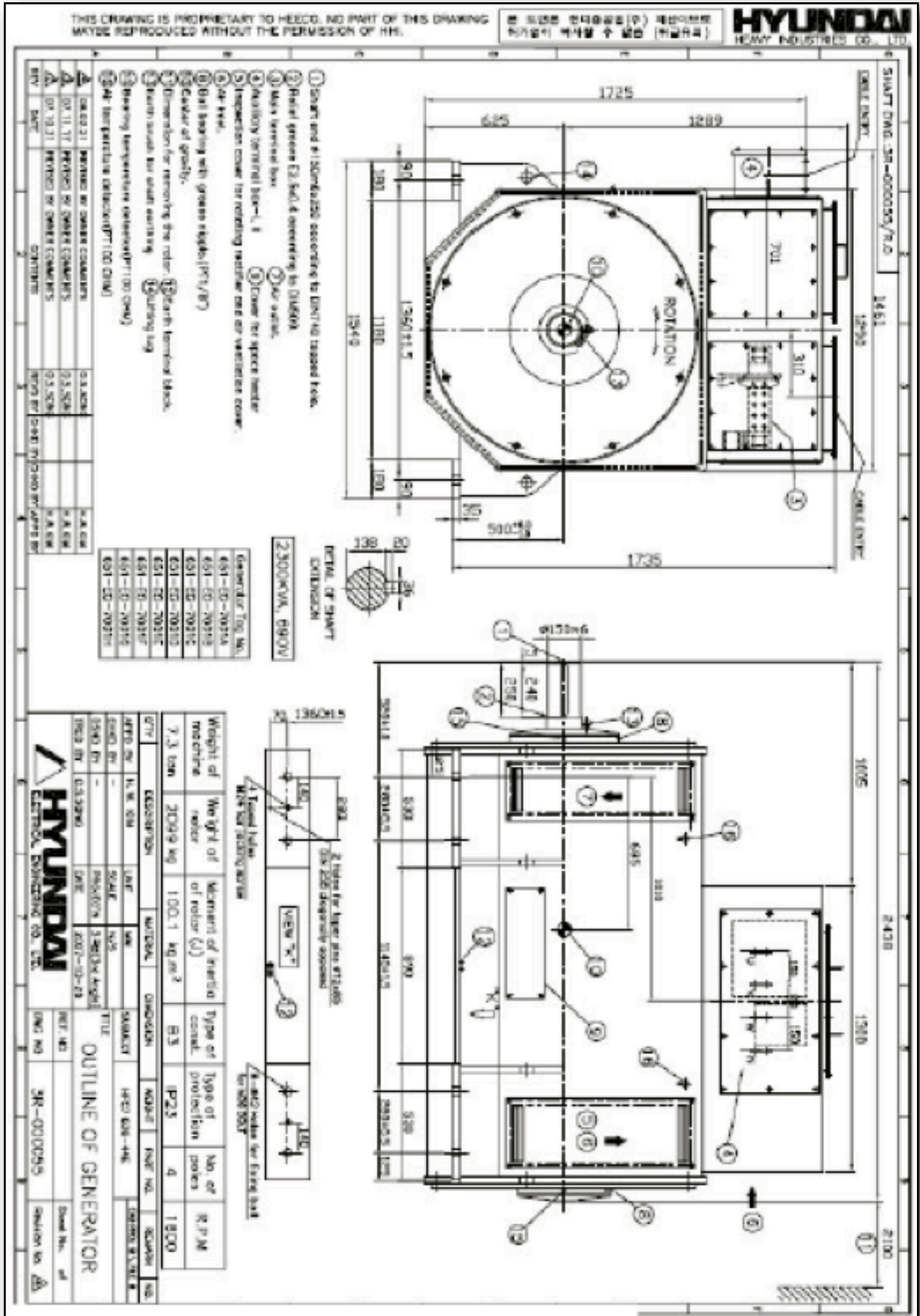

THREE [3] OFF - 440V HYUNDAI GENERATORS DIAGRAM

